

# Synthetic VA Flowmeters



## KM 35

### Operation

The flowmeters type KM 35 operate with the float measuring principle

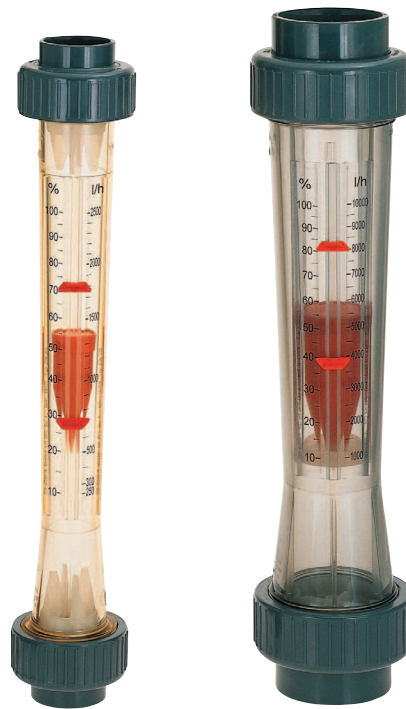

### Application

The flowmeters type KM 35 are used for measuring volume flow of liquid and gaseous media.



Areas of application:

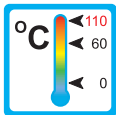

– Mechanical Engineering e.g. Welding machinery, Laser plants



– Medicine technology

– Pharmaceutical industry



– Research and development

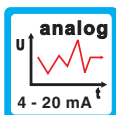
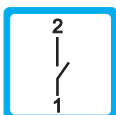

### Features

The model proves itself through reliable function and easy handling:

- high accuracy (Accuracy class 4)
- easy to read
- Good suitability for special media by choice between 4 different materials
- Scales can be exchanged subsequently, Special scales on request
- Glue connections or threaded connections

### Installation hints

The instrument must be installed vertically in the flow circuit. The flow direction is from bottom to top.

The flowmeter must not be used as a supporting part in a pipe construction!

The medium must not contain any solid particles!

KM35 1 0002 04-12 E M



# Technical Data

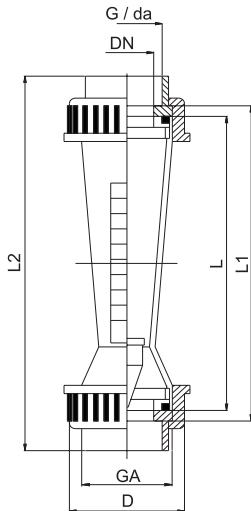

## Material

	Version PVC-U	Version PA	Version PSU	Version PVDF
Measuring tube	PVC-U	PA	PSU	PVDF
Float	PVDF*	PVDF*	PVDF*	PVDF*
Connection				
Glue connection	PVC			
Threaded connection				
standard:	PVC			
optional:	GTW, Brass, Stainless steel (1.4571)			
Gaskets				
standard:	EPDM			
optional:	FPM			

Standard exworks are glue connections.

\*optional liquidtight encapsulated magnets (Recording of measurement)

Other versions on request!

Type	Measuring range H <sub>2</sub> O [l/h]	Overall dimensions mm							Option G	Weight [g]
		da	DN	L	L1	L2	D	GA		
KM 35-6	60 - 600	32	25	350	356	400	60	1 1/2"	1"	475
KM 35-10	100 - 1000	32	25	350	356	400	60	1 1/2"	1"	475
KM 35-15	150 - 1500	40	32	350	356	408	72	2"	1 1/4"	710
KM 35-20	200 - 2000	50	40	350	356	418	83	2" 1/4"	1 1/2"	1050
KM 35-25	250 - 2500	40	32	350	356	408	72	2"	1 1/4"	710
KM 35-30	300 - 3000	50	40	350	356	418	83	2 1/4"	1 1/2"	1050
KM 35-40	400 - 4000	63	50	350	356	432	103	2 3/4"	2"	1530
KM 35-60	600 - 6000	63	50	350	356	432	103	2 3/4"	2"	1530
KM 35-100	1000 - 10000	63	50	350	356	432	103	2 3/4"	2"	1530
KM 35-150	1500 - 15000	75	65	350	356	444	122	3 1/2"	2 1/2"	2100
KM 35-250	2500 - 25000	75	65	350	356	444	122	3 1/2"	2 1/2"	2100
KM 35-500	10000 - 50000	75	65	350	356	444	122	3 1/2"	2 1/2"	2100

Technical data	KM 35	
Operating pressure max.:	see Pressure - Temperature - Diagram	
Pressure drop:	see table on page 3	
Temperature range:		
PVC-U	-10	bis +60 °C
PA	+5	bis +75 °C
PSU	+5	bis +100 °C
PVDF	0	bis +110 °C
Accuracy:	Accuracy class 4 according to VDE / VDI 3513 page 2	

## Pressure - Temperature - Diagram

The curves of the diagram present approximate values of the resistance of four different materials in relation to the operating temperature.

Pressure - temperature curves are valid for a calculated life - time of 20 years.

Among other factors the creep strength of the different materials must be considered when determining the permissible operating pressure.

As far as these details or operating temperatures under 0 °C are concerned, we ask you to inform us about the exact operating conditions.

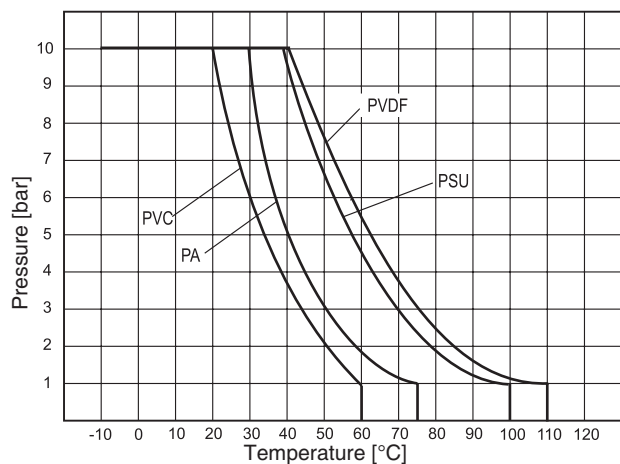

KM35.2 0004 04-12 E M



## Measuring ranges for water and air

Type	Range H <sub>2</sub> O [l/h]	Pressure drop H <sub>2</sub> O at 20 °C [mbar]	Range Air, 20 °C, 0 - 0,2 bar rel. [Nm <sup>3</sup> /h]	Pressure drop Air at 20 °C [mbar]
KM 35-6	60 - 600	12,3	2,0 - 21	15,9
KM 35-10	100 - 1000	12,3	3,0 - 34	15,9
KM 35-15	150 - 1500	12,3	5,0 - 50	15,9
KM 35-20	200 - 2000	12,3	8,0 - 70	15,9
KM 35-25	250 - 2500	12,3	7,0 - 80	15,9
KM 35-30	300 - 3000	12,3	10 - 100	15,9
KM 35-40	400 - 4000	22,2	14 - 125	27,1
KM 35-60	600 - 6000	22,2	20 - 200	27,1
KM 35-100	1000 - 10000	22,2	30 - 320	27,1
KM 35-150	1500 - 15000	33,7	50 - 500	40,0
KM 35-250	2500 - 25000	33,7	80 - 800	40,0
KM 35-500	10000 - 50000	33,7	300 - 1600	40,0

Type	Range Air 1 bar [Nm <sup>3</sup> /h]	Range Air 2 bar [Nm <sup>3</sup> /h]	Range Air 3 bar [Nm <sup>3</sup> /h]	Range Air 4 bar [Nm <sup>3</sup> /h]	Range Air 5 bar [Nm <sup>3</sup> /h]	Range Air 6 bar [Nm <sup>3</sup> /h]	Range Air 7 bar [Nm <sup>3</sup> /h]	Range Air 8 bar [Nm <sup>3</sup> /h]
KM 35-6	3,0 - 30	4,0 - 36	4,0 - 40	5,0 - 45	5,0 - 50	5,0 - 55	6,0 - 58	6,0 - 60
KM 35-10	5,0 - 50	5,0 - 60	5,0 - 70	6,0 - 75	10 - 84	10 - 90	10 - 96	7 - 100
KM 35-15	5,0 - 70	7,0 - 85	8,0 - 100	10 - 110	10 - 120	10 - 130	10 - 140	10 - 150
KM 35-20	10 - 100	10 - 120	12 - 135	20 - 150	15 - 170	15 - 180	20 - 190	15 - 200
KM 35-25	10 - 110	10 - 140	15 - 160	15 - 180	20 - 200	22 - 200	24 - 215	20 - 240
KM 35-30	15 - 140	20 - 160	20 - 190	20 - 220	20 - 240	30 - 260	30 - 280	30 - 280
KM 35-40	20 - 170	15 - 220	20 - 250	31 - 275	20 - 320	30 - 320	20 - 360	40 - 380
KM 35-60	30 - 280	30 - 380	40 - 400	50 - 500	50 - 500	60 - 520	60 - 580	60 - 580
KM 35-100	40 - 440	50 - 540	60 - 620	70 - 700	70 - 800	80 - 820	80 - 900	100 - 950
KM 35-150	80 - 700	80 - 800	102 - 880	114 - 980	125 - 1070	100 - 1300	144 - 1240	153 - 1300
KM 35-250	100 - 1200	140 - 1240	166 - 1400	185 - 1600	200 - 1750	220 - 1880	220 - 2200	250 - 2100
KM 35-500	400 - 2200	600 - 2500	700 - 2900	800 - 3200	800 - 3800	900 - 4000	1050 - 4100	1100 - 4300

The measuring ranges indicated in the table are approximate values at 20 °C.  
Other measuring ranges and gases on request.

**Caution: Do not use PVC - measuring tubes with Air / Gas - Application !**



# Limitswitch, Measuring Sensor

## Limitswitch SG-KM

The limitswitches SG-KM serve as event marker for min., max. or any inbetween value of the flow. They are fitted on the dove-tail of the measuring tube and trigger a signal when the float reaches or passes the switch. As soon as this happens the reed contact opens or closes. For this function the float must contain magnets.



SG-KM

### Type SG-KM-MO-S monostable (normally open)

The contact is closed, when the float is in line with the limitswitch. It opens (event) as soon as the float moves up or down away from the switch, which means increasing or decreasing flow.

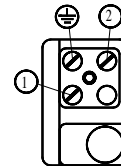

### Connection allocation

The polarity of the connectors does not influence the function

### Type SG-KM-BI-S/Ö bistable (normally open or normally closed)

The normally open contact closes as soon as the magnetfloat approaches (coming from the bottom) the limitswitch or is in line with the same. When overriding the limitswitch, the switchcondition remains. Only when overriding the limitswitch, the switchcondition will be cancelled.

The normally closed contact is closed under noflow condition and open under flow condition.

Remark: Before the first start up, the float has to pass the limitswitch at least 3 times in order to cancel the monostable behaviour!

Technical Data			
Operating voltage:	max. 230 V AC	Operating temperature:	0 °C bis +55 °C
Switch current:	max. 0,5 A	Ingress protection:	IP 65 (DIN 40050)
Switch power:	max. 10 W / 10VA	Hysteresis:	3 mm
Switch resistance:	< 150 mΩ	Dimensions:	34 x 17 x 41 mm
Insulating resistance:	> 10 <sup>11</sup> Ω	Weight (incl. plug):	40 g

The electrical max. values must not be exceeded!

## Measuring Sensor KME-3000

The KME-3000 detects the position of the magnetic float in the KM and generates a 4 ... 20 mA - signal.

Existing flow meters (with magnetic floats) can be upgraded easily.

This micro-processor controlled unit has to be programmed device-specific by Meister, therefore the customer has to specify the type of the flowmeter.

Screw clamps are used to fit the KME-3000 on the dovetail guide of the flowmeter. The plug connector is located in the upper section. During the installation, ensure that the notch of the KME-3000 coincides with the 50% mark on the flowmeter.



### Wiring diagram

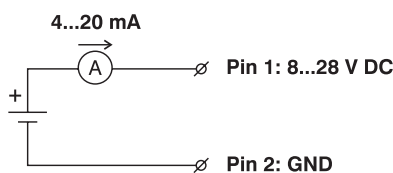

Once installed and the voltage is applied, press the 0 button (refer to right picture) for at least 2 sec to compensate surrounding magnetic influences. During this phase ensure that the float is in its bottom position i.e. no flow must take place.

During normal operation the 0 button must not be actuated! **0 button**



Technical Data		
Characteristics	Power supply	8...28 V DC
2-wire	Output	analog, 4 - 20 mA
Programming adapted to the specific KM	Output current 0 % → 100 % + Overrange	
Non-volatile value storage	During normal operation (Pin 1 - Pin 2)	
11-point calibration	Min:	4.0 → 20.1 mA
Lower limit value (low-cutoff): 0...99 % *	Typ.	4.0 → 21.0 mA
Factory settable time lag (low-pass-filter): 0.1...2.5s*	Max.	4.0 → 22.0 mA
0 button to compensate the surrounding magnetic influences	Connection	2-pole plug
Measuring accuracy better than 0.5 %	Ingress protection	IP 65
* adjustment according to customer requirements	Operating temperature	-30 ... +65 °C
	Material	plastics

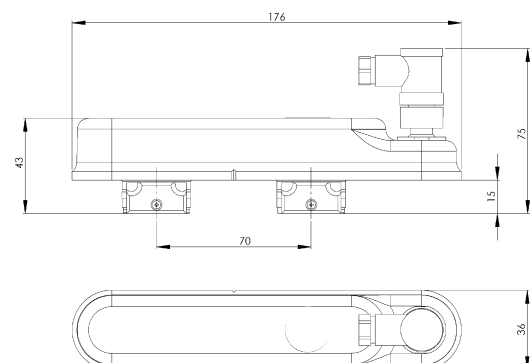

KM35 4 0003 12-10 E M



TR Automatyka Sp. z o. o.  
ul. Lechicka 14 ; 02-156 Warszawa

Tel. (+48 022) 886 10 16  
Fax. (+48 022) 846 50 37

[www.trautomatyka.pl](http://www.trautomatyka.pl)  
[biuro@trautomatyka.pl](mailto:biuro@trautomatyka.pl)