



**Electrical Ratings Type KD1**

Silver contacts	Inductive load	Resulting load
30 V =	3.0 A	5.0 A

	<b>IMPORTANT</b>
Data only valid for application in non-explosive atmosphere.	
We recommend to use a prefuse of the maximum current rating from the table above according to the load switched.	
As the lamp load is hardly relevant in the field we abstain from relating details. More information on request.	

**Electrical Ratings Type KLK/KLM**

Silver contacts	Inductive load	Resulting load	Gold plated contacts
30 V =	3.0 A	5.0 A	$U_{max}$ 30 V =
			$I_{max}$ 400 mA
			$(U \cdot I)_{max}$ 0.12 VA

	<b>IMPORTANT</b>
Data only valid for application in non-explosive atmosphere.	
We recommend to use a prefuse of the maximum current rating from the table above according to the load switched.	
We recommend gold plated contacts for all intrinsically safe and other applications with low voltage/power.	

**Operating life time**

Normal expected service life (expressed in the number of cycles over the full adjustment range) is appr. 1 million for KLK/KD1 the pressure switches and for the KLM approx 0.5 million. This may be extended to 2.5 million cycles for piston switches max. if only a part of the adjustment range is used (about 20%).

Switch sensor life may also be effected negatively by:

- Media not compatible with the wetted materials.
- Too high switch cycling speed or more than 60 cycles per minute.
- System cycling pressure exceeding the top of the adjustable range.
- Too high electrical ratings

The proof pressure must never be exceeded, otherwise the switch may be damaged. Careful selection of the pressure range ant the electrical ratiions can have a positive effect on the service life of the switch.

**Switching rate:** KLM: max 30/min                      KLK/KD1: max 60/min

**Operating Instructions**  
**Compact Pressure Switches Type KD1.../KLK.../KLM...**



1	Intended Applications .....	2
2	Safety Instructions.....	2
3	Standards .....	3
4	Warranty/Guaranty.....	3
5	Transport/Storage.....	4
6	Installation/Commissioning .....	4
7	Maintenance/Cleaning .....	7
8	Technical Data.....	8

**Barksdale GmbH**  
Dorn-Assenheimer Straße 27  
D-61203 Reichelsheim

Phone: +49 (6035) 949-0  
Fax: +49 (6035) 949-111 and 949-113  
email: info@barksdale.de  
Internet: www.barksdale.de

Art. No.: 923-0181  
Index I, 29.08.2011



Specifications are subject to changes without notice!

### Intended Applications

The pressure switches are specifically applied for monitoring and controlling of operations using maximum and minimum pressures. A micro switch triggers an electrical signal when minimum or maximum pressure are reached.

 <b>DANGER</b>
<p>The switch may only be used in the specified fields of application (see type label).</p> <p>The temperature has to be within the specified ranges, the pressure values and the electrical rating must not exceed the values specified.</p> <p>Observe also the applicable national safety instructions for assembly, commissioning and operation of the switch.</p> <p>The switch is not designed to be used as the only safety relevant element in pressurized systems according to DGR 97/23/EC.</p> <p>Without special provisions/actions, pressure switches must not be used for pure gas or hydrogen applications.</p>

### Safety Instructions

The safety instructions are intended to protect the user from dangerous situations and/or material damage.

In the operating instructions the seriousness of the potential risk is designated by the following signal words:

 <b>DANGER</b>
<p>Refers to imminent danger to men.</p> <p>Nonobservance may result in fatal injuries.</p>

 <b>WARNING</b>
<p>Refers to a recognizable danger.</p> <p>Nonobservance may result in fatal injuries, and destroy the equipment or plant parts.</p>

 <b>CAUTION</b>
<p>Refers to a danger.</p> <p>Nonobservance may result in light injuries and material damage to the equipment and/or to the plant.</p>

	<b>IMPORTANT</b>
Refers to important information essential to the user.	

	<p><b>Disposal</b></p> <p>The equipment must be disposed of correctly in accordance with the local regulations for electric/electronic equipment.</p> <p>The equipment must not be disposed of with the household garbage!</p>
---	--

### Standards

The standards applied during development, manufacture and configuration are listed in the CE conformity and manufacturer's declaration.

### Warranty/Guaranty

#### Warranty

Our scope of delivery and services is governed by the legal warranties and warranty periods.

#### Terms of guaranty

We guaranty for function and material of the compact pressure switch under normal operating and maintenance conditions in accordance with the statutory provisions.

#### Loss of guaranty

The agreed guaranty period will expire in case of:

- changes or modifications to the housing/switch/fitting
- incorrect use,
- incorrect installation or

incorrect handling or operation contrary to the provisions of these operating instructions.

No liability is assumed for any damage resulting therefrom, or any consequential damage.

### Transport/Storage

 <b>CAUTION</b>
Severe shock and vibrations should be avoided during transport. Storage should be dry and clean.

### Installation/Commissioning

 <b>DANGER</b>
Only install or uninstall the switch when deenergized (electrically and hydraulically/pneumatically). Pressure connection and electrical connection must be carried out by trained or instructed personnel according to state-of-the-art standards. The switch must only be installed in systems where the maximum pressure $P_{max}$ is not exceeded (see type label).

 <b>WARNING</b>
Pressure peaks and pressure shocks exceeding the maximum operating pressure are inadmissible. The maximum operating pressure is the upper final value of the adjustable range or, if specified, the pressure indicated as maximum operating pressure. Exceeding the max. operating pressure affects the performance and the life span of the product and may damage it. Pressure switches must be mounted vibrationless.

 <b>WARNING</b>
Check the switch regularly for functioning. If the switch does not work properly, stop operation immediately!

 <b>IMPORTANT</b>
All pressure switches are tested for proper functioning before they leave the factory. The factory proof pressures are stated on the type plate. All pressure switches are set to a fixed set point in the factory.

### Contact Protection

The micro switches used are normally suitable for both direct and alternating current operation. Inductive, capacitive and lamp loads may, however, considerably reduce the life expectancy of a micro switch and, under extreme circumstances, even damage the contacts.

Depending on the application spark suppression and current limiting is recommended (see succeeding figures).

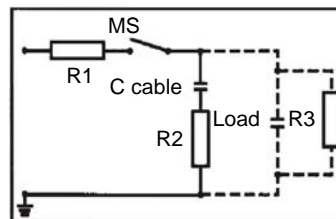

Fig. 1: Protection in case of capacitive loads  
R1: Protection against starting current rushes R2,R3: Protection against high discharge currents

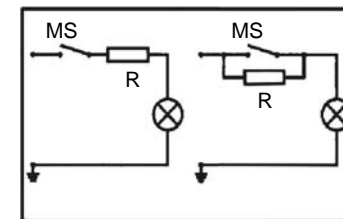

Fig. 2: Lamp load provided with resistance in parallel or series connection to switch of condensators

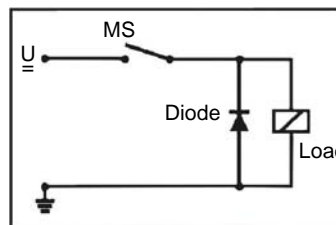

Fig. 3: Protection in case of continuous current and inductive load by recovery diode

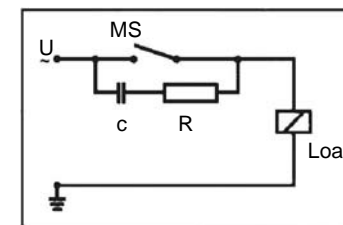



Fig. 4: Protection in case of alternating current and inductive load by RC-link

### Set point adjustment

The switch contact is factory set to the customer's requirements (see type plate).

 <b>IMPORTANT</b>
Factory-Provided: pressure (temperature) switch point setting We confirm for pressure (temperature) switches that have been factory set the setting will be detailed on the label name plate.  Warranty is not applicable for any changes that may occur due to transportation or installation. For critical applications we recommend the setting is checked and re-set if necessary after installation and wiring of the pressure (temperature) switch.

**Wiring Code for all Types** (Contact status at atm. pressure)

**KD1-K2**

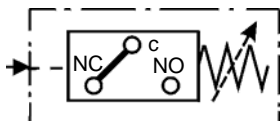

C = green  
NC = white  
NO = brown

**KD1-A1**

Normally Open NO

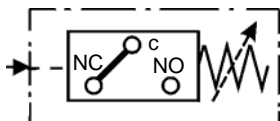

C = housing  
NC = not connected  
NO = spade connector 6.3 - DIN 46244

Normally Closed NC

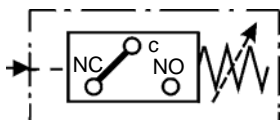

C = housing  
NC = spade connector 6.3 - DIN 46244  
NO = not connected

**KLK/KLM**

-K2

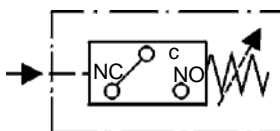

C = green  
NC = white  
NO = brown

-S1

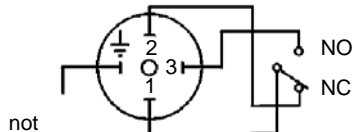

not

Fig. 5: Wiring Code

**Use in Hazardous Locations**

The pressure switches to be used in hazardous locations are principally designed for intrinsically safe circuits **i** following the applicable regulations and are provided with a blue plate bearing the words "For intrinsically safe **Ex i** application".

They must be operated with a switch amplifier as shown in Fig. 6. They are only for use in approved intrinsically safe circuits.

Switches with explosion-proof enclosures must be operated in accordance with their approval. Approval class and identification characteristics according to type plate information must always be observed.

EC-design approved types are marked with a type plate according to ATEX 94/9/EC.

The wiring between switch and **Ex i** isolation amplifier must meet the local safety requirements.

The customer must provide for a highly conductive connection between switch and grounding.

**Unprotected area**

**Ex ia area**

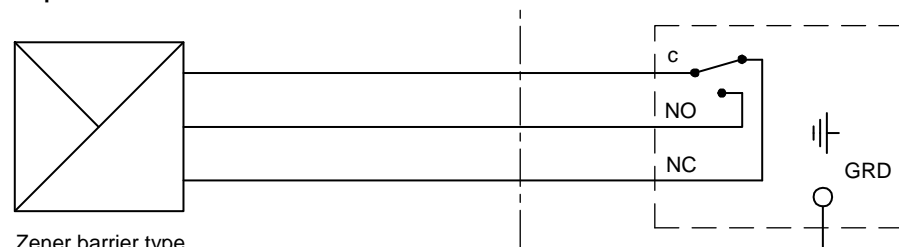

Zener barrier type  
Switch amplifier NAMUR

Fig. 6: Operation of pressure switches in intrinsically safe areas

**Maintenance/Cleaning**

**Maintenance**

The pressure switch is maintenance free. Checking the set points lies within the discretion of the user. The usual preventive maintenance work in accordance with the PED and ATEX guidelines must always be carried out.

**Technical Data**

See data sheet

**Dimensions** in mm (inch)

Silicone cable 3x0.5 mm<sup>2</sup>; 600 mm long

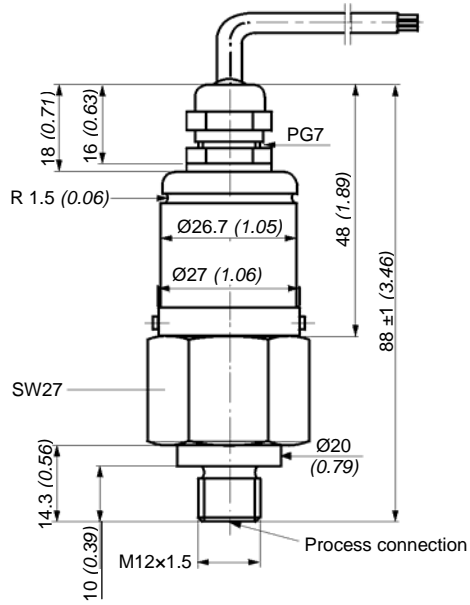

Fig. 7: Piston pressure switch type KD1-...-K2

Spade connector 6.3 - DIN 46244; green

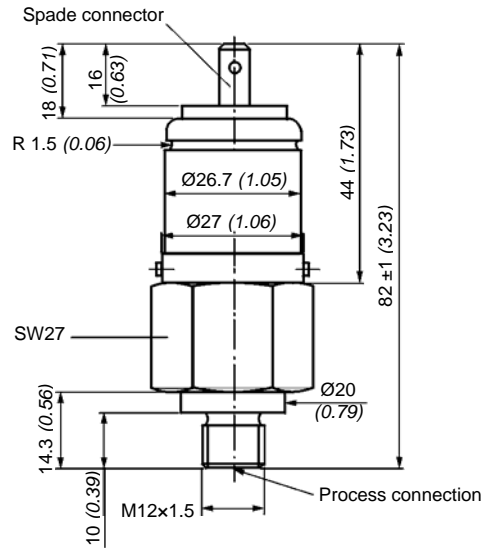

Fig. 8: Piston pressure switch type KD1-...-A1

Silicone cable 3x0.5 mm<sup>2</sup>; 600 mm long

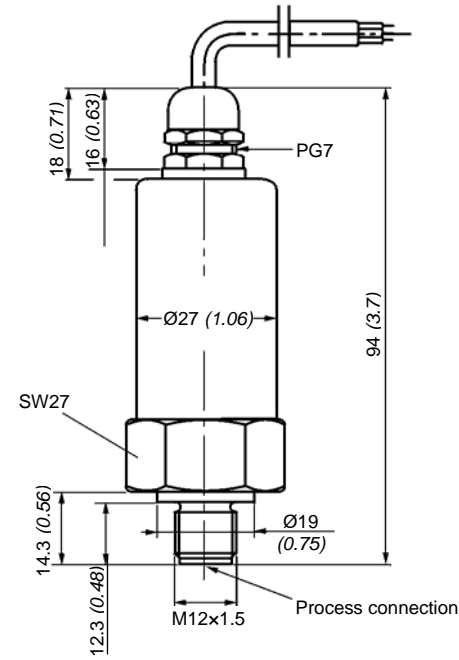

Fig. 9: Piston/diaphragm pressure switch type KLK/KLM-...-K2

Plug connector, 3-pin + E, EN 175301-803 C

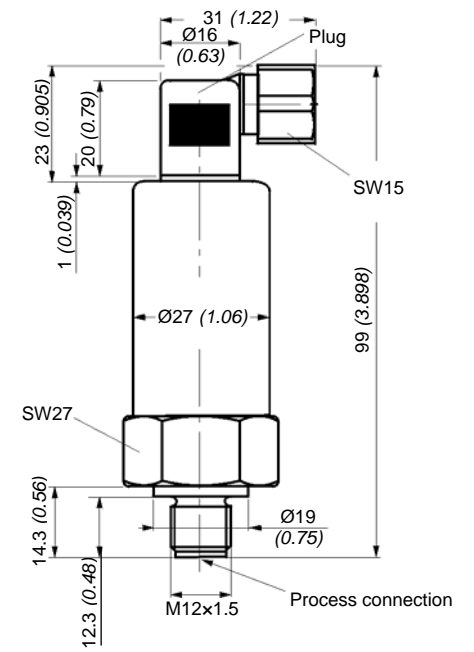

Fig. 10: Piston/diaphragm pressure switch type KLK/KLM-...-S1

**Approval data for pressure switches type KLK/KLM-...-K2**

Approval:  II 1 G D Ex ia IIC T6  
Ex ia D 20 T100

Certificate no.: ISSeP08ATEX016X

Permissible ambient temperature: -40 °C ... +75 °C

Electrical data for intrinsically safe application:  $U_i = 28V$   $I_i = 50\text{ mA}$   
 $C_i = 40\text{ pF}$   $L_i = 4\text{ }\mu\text{H}$

Standards applied: IEC 60079-0, IEC 60079-11, IEC 60079-26, IEC 61241-0 and IEC 61241-11

**Approval data for pressure switches type KLK/KLM-...-S1**

Approval:  II 1 G D Ex ia IIB T6  
Ex ia D 20 T100

Certificate no.: ISSeP08ATEX016X

Permissible ambient temperature: -40 °C ... +75 °C

Electrical data for intrinsically safe application:  $U_i = 28V$   $I_i = 50\text{ mA}$   
 $C_i = 40\text{ pF}$   $L_i = 4\text{ }\mu\text{H}$

Standards applied: IEC 60079-0, IEC 60079-11, IEC 60079-26, IEC 61241-0 and IEC 61241-11

**Adjustable ranges**

Order code	Adjustment ranges		Max. proof pressure [bar]	Max. operating pressure [bar]	Max. hysteresis (end of range)	
	Pressure					
			(short term)			
KD1 - 30/100	30...	100	450	300	16.5	19.0
KD1 - 60/300	60...	300	450	300	34.0	48.0
KLM-006	1...	6	80/200 *	40*	0.6	
KLM-025	5...	25	80/200 *	40*	2.6	
KLM-040	10...	40	80/200 *	40*	3.8	
KLK-100	30...	100	450	300	15	
KLK-300	60...	300	450	300	30	
KLK-400	150...	400	600	400	60	

\* Higher operating pressure (up to 150 bar) (with proof pressure 200 bar) on request. Please add to your order!